

LC-P1242P

DIMENSIONS (MM)



Contents indicated (including the recycle marking, etc.) are subject to change without notice.

FOR STANDBY POWER SUPPLIES.  
EXPECTED TRICKLE DESIGN LIFE: 10 - 12 YEARS AT 20°C  
ACCORDING TO EUROBAT.

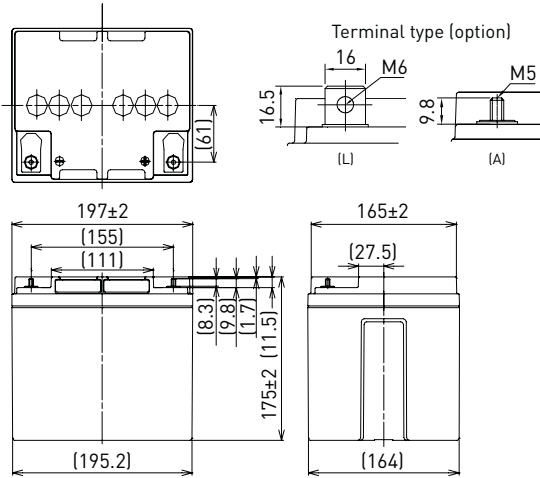

Battery case resin: flame retardant (UL94 V-0)

SPECIFICATIONS		
Name	LC-P1242P/AP	
Nominal voltage	12V	
Nominal capacity (20 hour rate)	42Ah	
Dimensions	Length	197mm
	Width	165mm
	Height	175mm/180mm
Approx. mass	13.5kg	
Terminal	M6 bolt/nut & M5 threaded post	
Capacity (25°C)	20 hour rate	42Ah
	10 hour rate	40Ah
	3 hour rate	32Ah
	1 hour rate	26Ah
Impedance	Fully charged battery (25°C)	10mΩ
Temperature dependency of capacity (20 hour rate)	40°C	102%
	25°C	100%
	0°C	85%
	-15°C	65%
Remaining capacity (25°C)	After 3 month	91%
	After 6 month	82%
	After 12 month	64%

DURATION OF DISCHARGE VS. DISCHARGE CURRENT

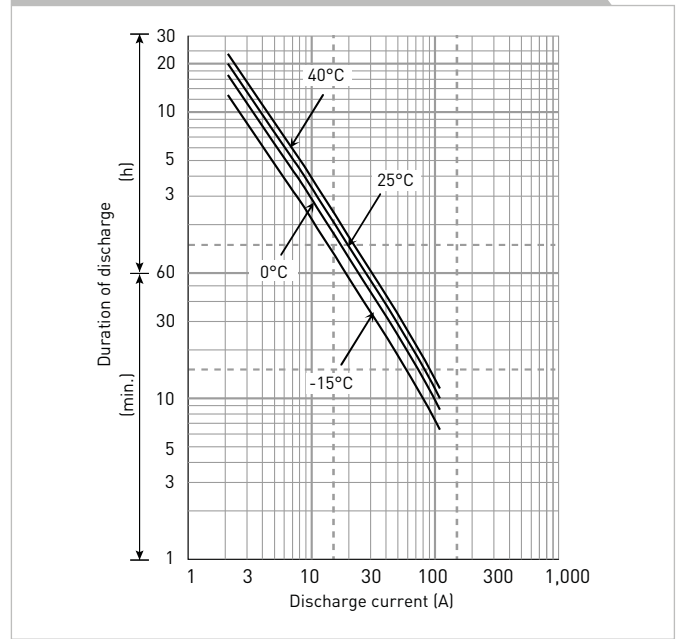

WATT TABLE (25°C)													[Wattage/battery]			
Cut-off	5min.	10min.	15min.	20min.	30min.	45min.	1h	1.5h	2h	3h	4h	5h	6h	10h	20h	
9.6V	1,483	1,254	966	835	625	410	312	241	187	132	110	89.9	79.1	48.0	25.2	
9.9V	1,405	1,232	955	824	607	407	310	234	186	130	109	89.4	78.5	48.0	25.2	
10.2V	1,327	1,210	943	812	596	406	307	217	184	127	108	88.9	77.9	48.0	25.2	
10.5V	1,249	1,176	920	800	585	405	306	211	179	126	107	88.5	76.7	48.0	25.2	
10.8V	1,215	1,086	886	777	573	390	295	201	173	121	105	87.5	75.5	48.0	25.2	

AMPERE TABLE (25°C)													[Ampere/battery]			
Cut-off	5min.	10min.	15min.	20min.	30min.	45min.	1h	1.5h	2h	3h	4h	5h	6h	10h	20h	
9.6V	133	112	84.0	72.0	53.4	34.9	26.5	20.4	15.8	11.1	9.20	7.50	6.60	4.00	2.10	
9.9V	126	110	83.0	71.0	51.9	34.7	26.3	19.8	15.7	10.9	9.10	7.46	6.50	4.00	2.10	
10.2V	119	108	82.0	70.0	50.9	34.6	26.1	18.4	15.5	10.7	9.00	7.42	6.50	4.00	2.10	
10.5V	112	105	80.0	69.0	50.0	34.5	26.0	17.9	15.1	10.6	8.90	7.38	6.40	4.00	2.10	
10.8V	109	97.0	77.0	67.0	49.0	33.2	25.0	17.0	14.6	10.2	8.80	7.30	6.30	4.00	2.10	

All mentioned values are average values

## LC-P1242P

### CHARGING METHOD (25°C)

**Trickle use** Control voltage: 13.6V - 13.8V  
Initial current: 6.30A or smaller

### CUT-OFF VOLTAGE

<b>Discharge current</b>	2.10A - 8.40A	8.40A - 21.0A	21.0A - 42.0A	42.0A - 84.0A	84.0A - 126A
<b>Cut-off voltage</b>	10.5V	10.2V	9.9V	9.3V	8.7V

### INFLUENCE OF TEMPERATURE ON TRICKLE LIFE

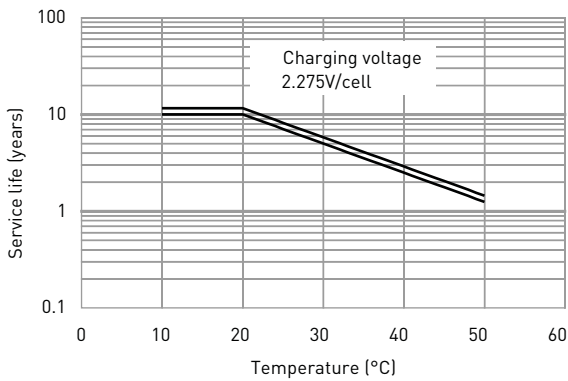

### RESIDUAL CAPACITY TEST RESULT

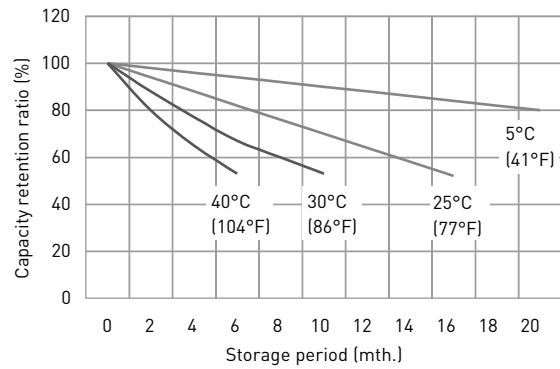

### CONSTANT-VOLTAGE CONSTANT-CURRENT CHARGE CHARACTERISTICS FOR TRICKLE USE

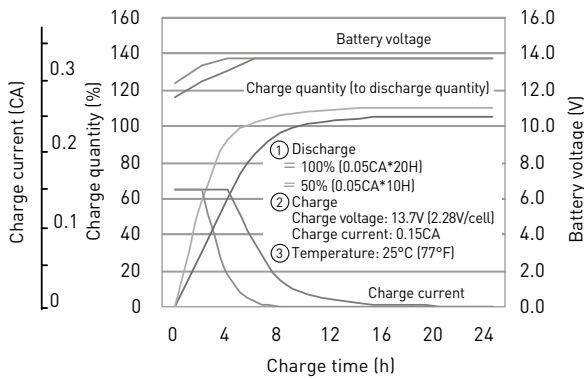

### DISCHARGE CAPACITY BY TEMPERATURE AND BY DISCHARGE CURRENT

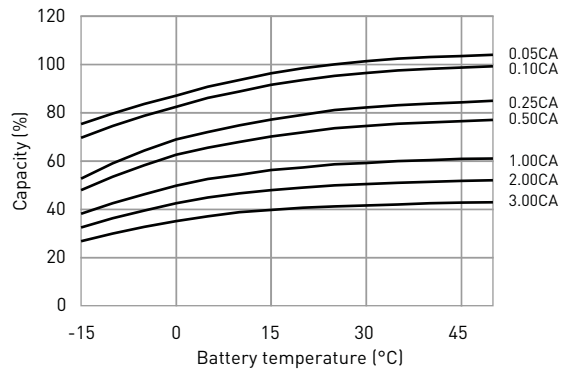

### DISCHARGE CHARACTERISTICS

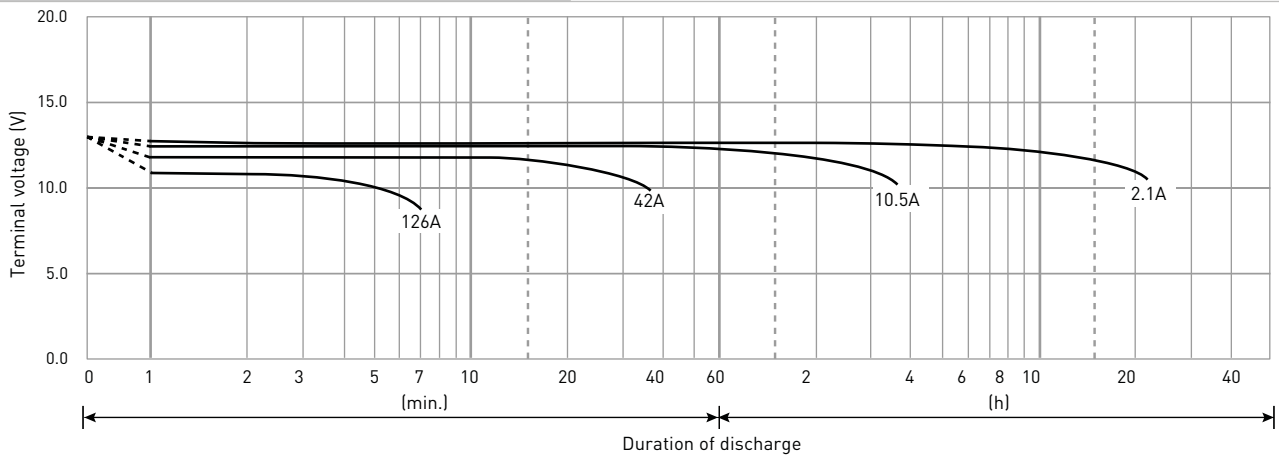

The data in this document are for descriptive purposes only and are not intended to make or imply any guarantee or warranty. Regarding handling and safety please consult our VRLA technical handbook chapter 1.